

LEFT SIDE COMPARTMENTATION				
COMPT	DOORS	INSIDE DIMENSIONS	DOOR OPENING DIMENSIONS	VOLUME
L1	DOUBLE	40"W X 66"H X 26"D	37"W X 59 1/2"H	37.4 CU. FT.
L2	LIFT-UP	59"W X 31 1/2"H X 26"D	57"W X 29 3/4"H	28.4 CU. FT.
L3	DOUBLE	51 1/2"W X 66"H X 26"D	48 1/4"W X 58 1/2"H	47.4 CU. FT.
L4/L5	LIFT-UP	82"W X 13.5"H X 19"D	75"W X 9.5"H	24 CU. FT.

  

RIGHT SIDE COMPARTMENTATION				
COMPT	DOORS	INSIDE DIMENSIONS	DOOR OPENING DIMENSIONS	VOLUME
R1	DOUBLE	40"W X 66"H X 26"D	37"W X 59 1/2"H	37.4 CU. FT.
R2	LIFT-UP	59"W X 31 1/2"H X 26"D	57"W X 29 3/4"H	28.4 CU. FT.
R3	DOUBLE	51 1/2"W X 66"H X 26"D	48 1/4"W X 58 1/2"H	47.4 CU. FT.
L4/L5	LIFT-UP	82"W X 13.5"H X 19"D	75"W X 9.5"H	24 CU. FT.

REAR STEP COMPARTMENT				
COMPT	DOORS	INSIDE DIMENSIONS	DOOR OPENING DIMENSIONS	VOLUME
A1	ROLL-UP	39 1/2"W X 28"H X 31"D	36 3/4"W X 19"H	19.8 CU. FT.

BASE STORAGE: 246 CU. FT.  
TOTAL STORAGE: 294 CU. FT.

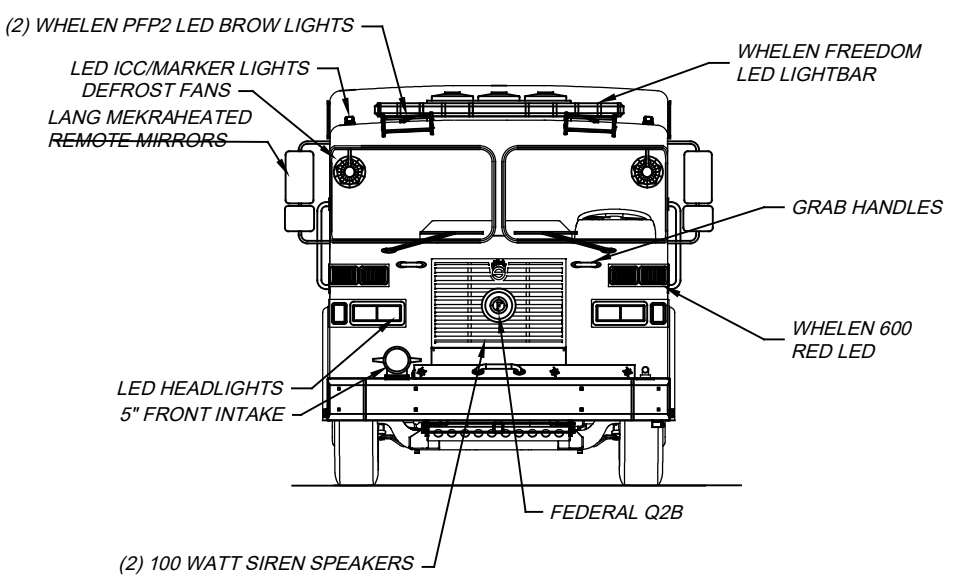

DIMENSIONS SHOWN ON THIS DRAWING ARE APPROXIMATE AND ARE SUBJECT TO MINOR DEVIATIONS DURING CONSTRUCTION.

IN THE EVENT OF A DISCREPANCY BETWEEN THE SUTPHEN SPECIFICATIONS AND DRAWING, THE SUTPHEN SPECIFICATIONS SHALL PREVAIL.

DRAWING IS FOR REFERENCE ONLY. SOME ITEMS PROPOSED MAY NOT BE SHOWN OR NOTED.

**CUSTOMER APPROVAL**

NAME: \_\_\_\_\_

TITLE: \_\_\_\_\_

DATE: \_\_\_\_\_

REV.	DESCRIPTION	BY	DATE

DRAWN BY:  
A.ALEXANDER

DATE:  
8/3/2022

MFG. FACILITY:  
URBANA PUMPER DIVISION

**SUTPHEN**

DELTA TOWNSHIP FIRE DEPARTMENT  
DELTA TOWNSHIP, MI

PROGRAM 1 CUSTOM PUMPER

DWG. NO.: HS-7386



**Sutphen**  
**Component Report**  
 Dealership: Apollo Fire  
 Equipment

**HS-7386 DELTA TOWNSHIP, MI**

Order#: SOB003187  
 Contact: GREG GINEBAUGH  
 Position: FIRE CHIEF  
 Phone: 517-321-6622  
 Mobile:  
 Email: GGINEBAUGH@deltami.gov

Bill To	Ship To
Customer: DELTA TOWNSHIP Contact: GREG GINEBAUGH, FIRE CHIEF Address: 7710 WEST SAGINAW HWY DELTA TOWNSHIP, MI 48917	Customer: Same as Bill-to Contact: GREG GINEBAUGH, FIRE CHIEF Address: 7710 WEST SAGINAW HWY DELTA TOWNSHIP, MI 48917

Comments
Project Coordinator: Austin Alexander Sales Person: David Desrochers Revision Level: Initial 8/2/22 Truck Type: G9 H/SM Body Facility: Urbana

Line	Item #	Qty	Item Description/Comments
1	10001200	1	MAXIMUM APPARATUS HEIGHT =
2		1	<i>Overall Apparatus Height = 9'10" +/- 2".</i>
3	10001220	1	MAXIMUM APPARATUS LENGTH =
4		1	<i>Overall Apparatus Length = 32'9" +/- 2".</i>
<b>CHASSIS</b>			
5	10010006	1	CHASSIS, CUSTOM
6	51070196	1	WHEELBASE = 196
7		1	<i>PTA Number = 95 AF Number = 54</i>
8	25010255	1	FRAME, 10" DOUBLE RAILS, DOMEX, SINGLE AXLE (110K PSI)
9	45010001	1	FRONT TOW EYES, BELOW BUMPER, PAINTED
10	46010000	1	REAR TOW EYES, PAINTED
11	40010250	1	STEERING - ROSS TAS-85
12	22010000	1	DRIVE LINE, SPICER, 1710 SERIES

Line	Item #	Qty	Item Description/Comments
13	23014130	1	ENGINE, CUMMINS L 9 450HP DOC-DPF-DEF-SCR OBD
14	23029100	1	ENGINE WARRANTY, 5 YEAR, 100,000 MILES FOR CUMMINS L9
15	23029300	1	AFTERTREATMENT WARRANTY, 5 YEAR, 100,000 MILES FOR CUMMINS L9
16	23030006	1	AIR INTAKE/EMBER SEPARATOR
17	23031173	1	FUEL FILTER/WATER SEPARATOR, PRIMARY, FLEETGUARD, FS1098
18	23031180	1	12VDC HEATER FOR FLEETGUARD FUEL/WATER SEPARATOR
19	23031210	1	FUEL FILTER, SECONDARY, FLEETGUARD, FF63009
20	47012430	1	TRANSMISSION, ALLISON GEN 5, EVS3000
21	23110005	1	JACOBS ENGINE BRAKE FOR CUMMINS L ENGINES
22	47024050	1	TRANSMISSION COOLER
23	47030000	1	ALLISON TOUCH PAD SHIFTER
24		1	<i>Shifter Pad Gearing = 5 Gears open, 6th Gear locked.</i>
25	21021200	1	COOLING SYSTEM
26	21030195	1	COOLANT FILTER
27	21030000	1	FAN CLUTCH
28	21030200	1	RADIATOR COOLANT RECOVERY, PRESSURIZED SYST
29	26010010	1	FUEL TANK, STAINLESS STEEL, 65 GAL
30	26030000	1	FUEL FILL
31	26030100	1	FUEL COOLER
32	24040000	1	DIESEL EXHAUST FLUID TANK
33		1	<i>DEF Access = Hinged Door for DEF Access.</i>
34	13012115	1	<b>ALTERNATOR, C.E. NIEHOFF 360 AMP CS27</b>
35	13030100	1	LOW VOLTAGE ALARM, FLOYD BELL TXB-V86-515-QF
36	15010500	1	BATTERIES, INTERSTATE TYPE 31 MHD (4)
37	15031700	1	BATTERY JUMPER TERMINALS
38	15030450	1	120V SHORELINE INLET, KUSSMAUL SUPER 20 AUTO EJECT W/ BUILT IN BAR GRAPH DISPLAY 091-55-234-XXX

Line	Item #	Qty	Item Description/Comments
39		1	<i>Shoreline Inlet Location = Driver's side of Cab, standard location.</i>
40		1	<i>Shoreline Cover Color = Red.</i>
41	15040100	2	<b>120V OUTLET WIRED TO SHORELINE INLET - EA (2)</b>
42		1	<i>Nema Number = 5-20 House Plug Duplex.</i>
43		1	<i>Outlet Locations = Location #1 = EMS Cabinet Behind Driver (Upper Inboard of cabinet) Location #2 = EMS Cabinet Behind Officer (Upper Inboard of cabinet)</i>
44	15031888	1	<b>SPECIAL Battery Charger KUSSMAUL 1500 AUTO INVERTER/CHARGER</b>
45		1	<i>Battery Charger Note: Chassis Division to provide/install battery charger &amp; Auto Eject (if applicable)</i>
46	14022120	1	<b>FRONT AXLE, HENDRICKSON STEERTEK NXT 20,000 LB.</b>
47	41022120	1	<b>FRONT SUSPENSION, HENDRICKSON 20,000 LBS. (4) 56" LEAFS</b>
48	41040510	1	<b>STEER ASSIST</b>
49	43010305	1	<b>FRONT TIRES, GOODYEAR 385/65R22.5 LRJ G296 22.5 x 12.25 WHEELS</b>
50	14510530	1	<b>REAR AXLE, MERITOR RS-26-185 27,000 LB.</b>
51	14530200	1	<b>TOP SPEED, OTHER</b>
52		1	<i>Top Speed = 70.</i>
53		1	<i>The top speed entered exceeds the NFPA recommendations of 68 MPH.</i>
54	42010015	1	<b>REAR SUSPENSION, FIREMAAX 27,000 LBS. AIR RIDE</b>
55	44010320	1	<b>REAR TIRES, GOODYEAR 12R22.5 LRH G622 MUD &amp; SNOW 24,000 - 27,000 GVWR</b>
56	42910300	1	<b>TIRE PRESSURE MONITOR, QUICK PRESSURE</b>
57	44210220	1	<b>WHEELS, ALUM, ALCOA, DURABLACK (max 27K rear)</b>
58	44270100	1	<b>HUB COVERS, FRONT &amp; REAR, POLISHED STS (Single Axle)</b>
59	44270300	1	<b>CHROME LUG NUT CAPS, FRONT &amp; REAR (Single Axle)</b>
60	44271100	1	<b>MUD FLAPS, FRONT (PAIR)</b>
61	44271200	1	<b>MUD FLAPS, REAR (PAIR)</b>
62	54010010	1	<b>DATA, SAFETY &amp; WARNING TAGS APPLICATION, ADHESIVE</b>
63	16010265	1	<b>BRAKES STEERTEK DISC PLUS EX225 FRONT, MERITOR DISC PLUS EX225 REAR (SINGLE AXLE)</b>

Line	Item #	Qty	Item Description/Comments
64	18010041	1	AIR BRAKE SYST 4 TANKS WABCO 1200 DRYER (24K, 27K)
65	18020000	1	CENTRAL LOCATION FOR AIR TANK DRAINS
66		1	<i>Specify Central Location for Air Tank Drain Valves =</i>
67	18030140	1	AIR INLET CONNECTION
68		1	<i>Standard Air Inlet Location = Left hand side of Driver's step well.</i>
69	18033000	1	KUSSMAUL 091-28 AIR EJECT W/FEM COUPLING
70		1	<i>Air Eject Location = Driver's side of Cab, standard location.</i>
71		1	<i>Air Eject Cover Color = Red.</i>
72	18220500	1	NO ELEC STABILITY CONTROL SYS
73	18110000	1	WABCO 4 CHANNEL ANTI-LOCK BRAKES (24K, 27K)
<b>CAB</b>			
74	11023250	1	CAB TSAL4E 73" 10" RR 1/2
75	11030950	1	CAB LOCKDOWN LATCHES
76			<i>Cab Latch Orientation Orient officer's side cab latch pin towards the frame rail when a front suction is provided.</i>
77	11031025	1	CAB TILT SYSTEM, AIR CONTROL VALVE
78		1	<i>Cab Tilt Controls = Officer's side Pump Panel.</i>
79	11031100	1	MANUAL BACK-UP TILT SYSTEM
80	11031350	1	CAB DOORS, FULL LENGTH (4)
81	11031386	1	CAB STEPS, LOWER & INTERMEDIATE DIAMONDPLATE
82	11031396	1	CAB STEP LIGHTING, FEDERAL SIGNAL COMPLEX LED STRIP LIGHTS
83	11031425	1	CAB DOOR WINDOWS, POWER W/AUTO ROLL-UP, WHEN PUMP IS ENGAGED (4)
84	11031400	1	DELETE CAB SIDE WINDOWS
85	11031460	1	NO WINDOWS, BACK WALL OF CAB
86	11031465	1	WINDOW TINTING (LIMO TINT 8%) - EACH (2)
87	52010010	1	ELECTRIC INTERMITTENT WIPERS
88	52030100	1	DEACTIVATE WINDSHIELD WIPERS WITH PARKING BRAKE ENGAGED

Line	Item #	Qty	Item Description/Comments
89		1	<i>Override Switch to Re-Engage Wipers? = Yes.</i>
90	52030210	1	WINDSHIELD WASHER RESERVOIR W/SENSOR & INDICATOR LIGHT
91	38010020	1	MIRRORS LANG MEKRA 300 SERIES HEATED & REMOTE
92	11024415	1	UPPER GRILLE, AMERICAN FLAG LEVEL STYLE FACADE (L9)
93	11024500	1	FLAMING "S" LOGO, UPPER GRILLE, REFLECTIVE RED
94	11024600	1	<b>LOWER GRILLE, POLISHED STAINLESS (L9)</b>
95	20012220	1	BUMPER, 24" FORMED STEEL CHANNEL, PAINTED
96		1	<i>Siren Speaker Perforations = No Speaker Perforations in Bumper.</i>
97	20029810	1	BUMPER SIDES, PAINTED STEEL, FLAT (12"-24" EXTENSION)
98	20029920	1	BUMPER ANGLES, PAINTED STEEL, W/ POCKET (12-24" EXTENSION)
99		1	<i>PLACE M6V LIGHTS IN POCKET</i>
100	20040230	1	STORAGE WELL, DEEP CENTER, 3/4 WIDTH (24" BUMPER)
101	20040300	1	1" LIP AROUND BUMPER TROUGH
102	20030120	1	STORAGE WELL COVER, TREADPLATE, 4" RAISE
103	20030510	1	CUT-OUT IN STORAGE WELL COVER
104		1	<i>Cut-Out for Treadplate Storage Well Cover = MATCH HS-6820</i>
105	20042140	1	PROTECTIVE BUMPER COATING, RAPTOR, TOP EDGE OF FRONT BUMPER
106		1	<i>Protective Bumper Coating Color = BLACK.</i>
107	20050300	1	WINCH RECEIVER, FRONT
108	20050395	1	WIRING FOR WINCH RECEIVER (1)
109		1	<i>Type of Plug for Winch Receiver = Grey</i>
110	20088888	1	SPECIAL ITEM, DIVIDER
111		1	<i>DIVIDER ON OFFICER SIDE OF FRONT BUMPER, FOR 50' ROLL OF 5" LDH Divider on adjustable Unistrut track Match HS-6820</i>
112	12010400	1	AIR HORNS, DUAL, HADLEY H00978 RECTANGULAR, BEHIND PERFORATION
113		1	<i>Air Horns Location: Inboard, (1) each side.</i>
114	12030010	1	AIR HORNS CUTOUTS IN BUMPER, BEHIND PERFORATIONS (L9 STYLE)

Line	Item #	Qty	Item Description/Comments
115	12030350	1	LANYARD CONTROL FOR AIR HORNS
116	12510110	1	WHELEN CORE CONTROLLER CCTL6
117			Core Controller and syncs will be provided Core System and programming to be installed by Apollo
118	12620202	1	SIREN SPEAKER, 100W, WHELEN, SA314B, BLACK FINISH (PAIR)
119	12670110	1	SIREN SPEAKER(S) INSTALLED BEHIND CAB GRILLE
120	12710100	1	SIREN, FEDERAL Q2B, GRILLE MOUNT
121		1	Q2B Wiring = Wired to Emergency Master then shed with parking brake on.
122	12730305	1	FOOT SWITCH, DRIVER'S SIDE, FOR MECH SIREN
123	12730350	1	MOMENTARY SWITCH ON DASH, OFFICER'S SIDE, FOR MECH SIREN
124	12730363	1	SIREN BRAKE SWITCH FOR MECH SIREN, DRIVER'S & OFFICER'S SIDE
125	32520520	1	HEADLIGHTS, LED, FIRETECH FT-4X6, DUAL STS HOUSINGS
126		1	Headlight Interior Finish = Chrome.
127	48010300	1	FRONT TURN SIGNALS, WHELEN 400 SERIES LED (4)
128	32530750	1	ICC LIGHTS, LED, ROOF MOUNTED MARKERS, GROTE
129	27022130	1	HANDRAILS, CAB EXTERIOR, KNURLED STAINLESS STEEL (2) SIDE
130	27030620	1	COAT HOOKS ON LOWER GRAB HANDRAILS, DRIVER'S SIDE (1)
131	27030660	1	COAT HOOKS ON LOWER GRAB HANDRAILS, OFFICER'S SIDE (1)
132	27030710	1	HANDRAILS, FRONT OF CAB, KNURLED STAINLESS STEEL (PAIR)
133	27025000	1	HANDRAILS, CAB INTERIOR, BLACK RUBBER COATED (2) FRONT ENTRY
134	27025500	1	HANDRAILS, CAB INTERIOR, BLACK RUBBER COATED (2) REAR ENTRY
135	27030110	1	HANDRAILS, REAR CAB INTERIOR DOOR, KNURLED STS AT WINDOW (2) ONLY
136	11032020	1	EXTERIOR COMPT, SIDE OF EXT CAB, 60" H, DS
137	11032450	1	COMPT DOOR LOCK - NOT PROVIDED
138	11032220	1	INTERIOR ACCESS, ALUMINUM HINGED DOOR
139	11032450	1	COMPT DOOR LOCK - NOT PROVIDED
140	11032100	1	NO OPENING TO CREW SEAT COMPT

Line	Item #	Qty	Item Description/Comments
141	11032070	1	EXTERIOR COMPT, SIDE OF EXT CAB, 60" H, OS
142	11032450	1	COMPT DOOR LOCK - NOT PROVIDED
143	11032200	1	INTERIOR ACCESS, NOT PROVIDED
144	11032100	1	NO OPENING TO CREW SEAT COMPT
145	11032340	4	SCBA BRACKET, EXTERIOR CAB COMPT (4)
146		1	<i>Location of Accessories in Ext Cab Compt = 2 each Driver's Side and Officer's Side mounted on back wall towards rear of cab mid height (space for Scott 45 Minute bottles)</i>
147	11035400	1	DIAMONDPLATE REAR EXTERIOR WALL OF CAB
148	11035420	1	DIAMONDPLATE CAB ROOF 30" x FULL WIDTH
149	31010250	1	INTERIOR, MULTISPEC BLACK SPECKLE PAINT W/BLACK EMBOSSED FRP BOARD
150	11032929	1	DOOR PANEL, FULL STS
151	11032958	1	REFLECTIVE MATL, INTERIOR CAB DOORS, CHEVRONS, REFLEXITE
152		1	<i>Reflective Striping Color = #030 Red Transparent &amp; #L2 Fluorescent Lime.</i>
153		1	<i>Reflective Striping Verbiage = "SUTPHEN"</i>
154	31010291	1	CAB INTERIOR FLOOR COVERING, BLACK RUBBERIZED
155	11035375	1	DIAMONDPLATE CAB FLOOR
156	22510100	1	ENGINE ENCLOSURE, FULL LENGTH
157	22510530	1	ENGINE ENCLOSURE COVERING, SCORPION BLACK URETHANE BLEND
158	11031670	1	TOOL MOUNTING PLATE, TOP OF ENGINE ENCLOSURE, NOT PROVIDED
159	11031680	1	CENTER CONSOLE W/MAP BOOK STORAGE, TOP OF ENGINE ENCLOSURE
160	22610050	1	ENGINE HOOD LIGHT, LED (1)
161	11031510	1	FLAT WORK SURFACE IN LIEU OF GLOVE BOX
162	11031710	1	UPPER CREW DOOR AREA, SMOOTH PANEL
163	29810100	1	CHASSIS ELECTRICAL DESCRIPTION
164	30010130	1	INSTRUMENTATION, AMETEK W/ CENTER & OVERHEAD CONSOLES



Line	Item #	Qty	Item Description/Comments
			<p>Upper Command Console:</p> 
165		1	<i>Overhead Console Panel's Finish: Black Wrinkle.</i>
166		1	<i>Overhead Console Position 1 Switches</i> #1 Master Emergency #2 Brow #3 Left Scene #4 Right Scene #5 Rear Scene #6 Blank #7 Blank #8 Blank #9 Blank #10 Acknowledge
167		1	<i>Overhead Console Position 2</i> Stereo AM/FM/WB/BT
168		1	<i>Overhead Console Position 3</i> HVAC controls, Camera Monitor Mounting Below
169		1	<i>Overhead Console Position 4</i> Door Open Indicators, Seat belt monitor, Air Horn Lanyard
170		1	<i>Overhead Console Position 5</i> Blank
171		1	<i>Overhead Console Position 6</i> Blank
172		1	<i>Overhead Console Position 7 Switching</i> #1 Master Emergency #2 Brow #3 Left Scene #4 Right Scene #5 Rear Scene #6 Blank #7 Blank #8 Blank #9 Blank #10 Blank
173	30010500	1	<b>LOWER COMMAND CONSOLE, L9 &amp; X12</b>

Line	Item #	Qty	Item Description/Comments
			<p>Lower Command Console (9L &amp; 12L engines):</p>
174		1	Lower Command Console Finish: Black Urethane.
175		1	Lower Console Panel's Finish: Black Wrinkle.
176		1	Lower Console Position 1 Pump and Transmission Shifters
177		1	Lower Console Position 2 Switches #1 Jake Brake on/off #2 Jake Brake hi/med/low #3 High Idle #4 Siren Brake #5 Blank #6 Blank #7 Blank
178		1	Lower Console Position 3 Park Brake CCTL6 CORE CONTROLER MOUNTED LOW Traffic Advisor Control Head 12v Power point Driver Corner USB Power point Driver Corner 12v Power point Officer Corner USB Power point Officer Corner
179		1	Lower Console Position 4 Blank
180		1	Lower Console Position 5 Switches #1 Mechanical Siren #2 Siren Brake #3 Blank #4 Blank #5 Blank #6 Blank #7 Blank
181	30010610	1	CAB PUMP SHIFTER, ELECTRIC W/ROUND KNOB (FOR HALE G-SERIES / WATEROUS C20 PUMP TRANSMISSION)
182	30011000	1	PUMP INTERLOCK, NOT CONNECTED WITH ODOMETER

Line	Item #	Qty	Item Description/Comments
183	30031615	1	<b>DO NOT MOVE LIGHT, WHELEN ION-T LED</b>
184		1	<i>Details for Door Ajar Light = Color = Red Lens Color = Clear</i>
185		1	<i>Door Ajar Light Location = Centered below upper command console.</i>
186	30031650	1	<b>DO NOT MOVE ALARM</b>
187	30031675	1	<b>DO NOT MOVE DISENGAGE BUTTON</b>
188		1	<i>Door Ajar / Door Not Move Disengage Button Location = "Acknowledge" in UCC#1 Switch 10</i>
189	29930200	1	<b>MAPBOOK SLOT ON BREAKER PANEL</b>
190		1	<i>Electrical System = Point-to-Point</i>
191	29910100	1	<b>PROGRAMMABLE LOAD MANAGER, CLASS-1 SUPERNODE II</b>
192	30031100	1	<b>HIGH IDLE SWITCH</b>
193	30031775	1	<b>12V POWER POINTS, (2)</b>
194		1	<i>Power Point Location #1: Lower Console Position 3, Driver's corner.</i>
195		1	<i>Power Point Location #2: Lower Console Position 3, Officer's corner.</i>
196	30031802	1	<b>12V DUAL PORT USB POWER POINTS, (2)</b>
197		1	<i>USB Power Point Location #1: Lower Console Position 3, Driver's corner.</i>
198		1	<i>USB Power Point Location #2: Lower Console Position 3, Officer's corner.</i>
199	11040000	1	<b>CAB ACCESSORY FUSE PANEL</b>
200	84541540	1	<b>POWER &amp; GROUND STUDS, UPPER COMMAND CONSOLE</b>
201		1	<i>Requirements (AMPS) for Power/Ground Studs in Upper Command Console: (1) 12-volt 60-amp, direct to the battery ignition off. (1) 12-volt 30-amp switched battery first position on ignition switch. (1) 12-volt 30-amp ignition power second position on ignition switch. (1) 12-volt 125-amp ground.</i>
202	84541545	1	<b>POWER &amp; GROUND STUDS, LOWER COMMAND CONSOLE</b>
203		1	<i>Requirements (AMPS) for Power/Ground Studs in Lower Command Console: (1) 12-volt 60-amp, direct to the battery. (1) 12-volt 30-amp controlled by the ignition switch. (1) 12-volt 125-amp ground.</i>
204	30110000	1	<b>VEHICLE DATA RECORDER, AKRON/WELDON</b>
205	33510030	1	<b>INTERIOR CAB LIGHTS, WHELEN 6" ROUND RED/CLEAR LED (2)</b>

Line	Item #	Qty	Item Description/Comments
206	34010030	1	INTERIOR CREW LIGHTS, WHELEN 6" ROUND RED/CLEAR LED (2)
207	33530654	1	INTERIOR CAB DOOR WARNING LIGHTS, WHELEN ION T-SERIES LED, TLI* (QTY 4)
208		1	<i>Cab Door Light Color = Green</i>
209	28010740	1	DEFROSTER, HEATER & A/C (TM-21)
210	28090003	1	HEAT TO FEET
211	28090100	1	A/C TO FACE
212	28030500	1	DEFROSTER DUCTWORK, ENTIRE WINDSHIELD
213	11031687	1	TOP HEAT/AC STORAGE, TOOL MOUNTING PLATE, 25" x 19.5"
214	11031696	1	REAR HEAT/AC STORAGE, 5 SLOTS (3 SMALL, 2 MEDIUM), SLANTED CORNERS
215	28031001	1	FAN, 12 VOLT, DRIVER'S SIDE, MOUNTED OUTBOARD OF WINDSHIELD
216	28031101	1	FAN, 12 VOLT, OFFICER'S SIDE, MOUNTED OUTBOARD OF WINDSHIELD
217	38510204	1	DRIVER'S SEAT, BOSTROM SIERRA ELECTRIC ABTS (DURAWEAR PLUS, LOW SEAM)
218	39010131	1	OFFICER'S SEAT, BOSTROM SIERRA, ABTS HIGH BACK (DURAWEAR PLUS, LOW SEAM)
219	39030020	1	OFFICER'S SEAT COMPT, FRONT DOOR
220	39521475	1	CREW SEAT 3, BOSTROM SIERRA, ABTS HIGH BACK (DURAWEAR PLUS, LOW SEAM)
221	39521476	1	CREW SEAT 4, BOSTROM SIERRA, ABTS HIGH BACK (DURAWEAR PLUS, LOW SEAM)
222	38320000	1	HELMETS STORED IN COMPARTMENT
223	39550200	1	SEAT COLOR, BLACK
224	39530710	4	BOSTROM ZIP CLEAN REMOVABLE COVERS, BOTTOM SEAT CUSHION, INCLUDES AN ADDITIONAL COVER (PER SEAT) (4)
225	39530720	4	BOSTROM ZIP CLEAN REMOVABLE COVERS, BACK REST (4)
226	38410000	1	SEAT BELT WARNING SYSTEM, AKRON / WELDON
227	11031821	1	EMS CABINET, REAR FACING, BEHIND DRIVER
228			<i>Extend outboard side of compartment to be flush with exterior wall (as if making an exterior door) Match HS-6820 for Design</i>
229	11032210	1	INTERIOR ACCESS, BLACK WEBBING
230			<i>Metal Airplane Latches</i>
231	11032312	1	ADJUSTABLE SHELVES, EMS COMPT (2)

Line	Item #	Qty	Item Description/Comments																
232	11031822	1	EMS CABINET, REAR FACING, BEHIND OFFICER																
233			<i>Extend outboard side of compartment to be flush with exterior wall (as if making an exterior door)</i>																
234	11032210	1	INTERIOR ACCESS, BLACK WEBBING																
235			<i>Metal Airplane Latches</i>																
236	11032312	1	ADJUSTABLE SHELVES, EMS COMPT (2)																
237	39710015	1	CREW SEAT COMPT, FRONT DROP-DOWN DOORS (73" CAB)																
238	11031740	1	OVERHEAD STORAGE, FRONT OF 10" RR W/NET																
239			<i>Extend down over Head Console to be flush with the top of the Rear Facing EMS Cabinets</i>																
240	11031748	1	OVERHEAD STORAGE, REAR OF 10" RR W/NET, CENTER ONLY																
241	30080150	1	HD STEREO, JENSEN, AM/FM/WB/BT																
242	84530288	1	SPECIAL Intercom DAVID CLARK 5 POSITION																
243		1	<i>Intercom Special Requirements (Radio Interface, Etc.) WIRELESS DAVID CLARK SYSYTEM, FOUR IN CAB, ONE AT THE PUMP PANEL</i>																
244			<table border="0"> <tr> <td><i>(1) AX10064725</i></td> <td><i>(1) AX10042323</i></td> </tr> <tr> <td><i>(1) AX10066455</i></td> <td><i>(2) C3821-05</i></td> </tr> <tr> <td><i>(1) AX10064732</i></td> <td><i>(2) AX10042317</i></td> </tr> <tr> <td><i>(1) AX10064721</i></td> <td><i>(1) AX10042322</i></td> </tr> <tr> <td><i>(3) AX10048587</i></td> <td><i>(1) AX10007428</i></td> </tr> <tr> <td><i>(1) AX10066316</i></td> <td><i>(1) 09271P-34HA000 (ORDER BY LENGTH)</i></td> </tr> <tr> <td><i>(1) AX10067782</i></td> <td><i>(1) AX10007427</i></td> </tr> <tr> <td><i>(1) C3019B</i></td> <td></td> </tr> </table>	<i>(1) AX10064725</i>	<i>(1) AX10042323</i>	<i>(1) AX10066455</i>	<i>(2) C3821-05</i>	<i>(1) AX10064732</i>	<i>(2) AX10042317</i>	<i>(1) AX10064721</i>	<i>(1) AX10042322</i>	<i>(3) AX10048587</i>	<i>(1) AX10007428</i>	<i>(1) AX10066316</i>	<i>(1) 09271P-34HA000 (ORDER BY LENGTH)</i>	<i>(1) AX10067782</i>	<i>(1) AX10007427</i>	<i>(1) C3019B</i>	
<i>(1) AX10064725</i>	<i>(1) AX10042323</i>																		
<i>(1) AX10066455</i>	<i>(2) C3821-05</i>																		
<i>(1) AX10064732</i>	<i>(2) AX10042317</i>																		
<i>(1) AX10064721</i>	<i>(1) AX10042322</i>																		
<i>(3) AX10048587</i>	<i>(1) AX10007428</i>																		
<i>(1) AX10066316</i>	<i>(1) 09271P-34HA000 (ORDER BY LENGTH)</i>																		
<i>(1) AX10067782</i>	<i>(1) AX10007427</i>																		
<i>(1) C3019B</i>																			
245	84560230	1	CAMERA SYSTEM, SAFETY VISION SV-CLCD0-70 (WIRED)																
246		1	<i>Camera Mounting Location Rear of Body.</i>																
247		1	<i>Camera Monitor Mounting Location Below Overhead Command Console Position 3.</i>																
248	11088888	1	SPECIAL ITEM, SPECIAL DUAL GLOVEBOX ON FRONT OF AC TOOL PLATE																
249		1	<i>PLEASE INSTALL AS SHOWN IN REFERENCE PHOTO</i>																

Line	Item #	Qty	Item Description/Comments
			
250	11088888	1	SPECIAL ITEM, MOUNT FD PROVIDED ANTENNAS
251			<p>Antenna Termination to be in ** **</p> <p>Antenna to be provided by 3/1/23</p> <p>Send to (Austin Alexander)</p> <p>UPS with tracking number preferred</p> <p>Do not send US postal</p> <p><b>Sutphen Corporation</b>  1653 W. County Line Rd.  Urbana, OH 43078</p>
252	84541600	1	MOUNTING OF CUSTOMERS RADIO-SINGLE HEAD
253			Location = Make = Model =
254	84588888	2	SPECIAL ITEM, EXTERIOR STORAGE FOR NY STYLE ROOF HOOK
255			To be attached to the back wall of the Cab (1) on DS and (1) on OS Match HS-6820
<b>PUMP &amp; PLUMBING</b>			
256	60080020	1	PUMP, HALE QMAX XS 1500 GPM SINGLE STAGE
257	60025000	1	GEARBOX, HALE, G-SERIES, REAR MOUNTED
258	60025950	1	PUMP GEARBOX YOKE, 1710
259	60026000	1	PUMP PACKING, HALE
260	60031005	1	ALLOY ANODES, HALE (2)
261	60035123	1	PUMP TEST, THIRD PARTY TESTING
262	61510000	1	AUXILIARY COOLER (HEAT EXCHANGER)
263	62010002	1	STAINLESS STEEL PIPING

Line	Item #	Qty	Item Description/Comments
264	66090010	1	3" TANK-TO-PUMP W/CHECK VALVE
265	73090001	1	TANK FILL 2"
266			<i>Tank fill to be located on the Officer's side of the tank</i>
267	61729120	1	VALVE, AKRON, HEAVY DUTY (ALL)
268	60036010	1	THREADS, NST (ALL)
269	61090003	1	PRESSURE GOVERNOR, CLASS 1 TPGJ1939
270	61290020	1	INTAKE PRESSURE CONTROL, TFT A1860
271	63021500	1	6" MAIN SUCTION, LEFT SIDE
272	63090001	1	HALE MASTER INTAKE VALVE, ELEC (SIDE SUCTION)
273	63060100	1	RELIEF VALVE FOR MIV
274	63034650	1	ADAPTER, 6" NST FE X 5" STORZ, 30 DEGREE W/CAP & CHAIN, TFT
275	65090000	1	2.5" LEFT SIDE INLET
276	63025500	1	6" MAIN SUCTION, RIGHT SIDE
277	63090001	1	HALE MASTER INTAKE VALVE, ELEC (SIDE SUCTION)
278	63060100	1	RELIEF VALVE FOR MIV
279	63034650	1	ADAPTER, 6" NST FE X 5" STORZ, 30 DEGREE W/CAP & CHAIN, TFT
280	65550910	1	5" FRONT SUCTION, TOP
281	63090002	1	HALE MASTER INTAKE VALVE, ELEC (FRONT SUCTION)
282	63060100	1	RELIEF VALVE FOR MIV
283	65552120	1	SWIVEL, 5" NPT X 6" NST
284	65588888	1	SPECIAL ITEM, STORZ ADAPTER
285		1	MATCH HS-6820 (1) AX10103527 (1) AX10035503 (1) AX10049950
286	70525900	1	2.5" DISCHARGE, LEFT - POSITION 1
287	61810150	1	DISCHARGE TERMINATION, 30 DEGREE ELBOW
288	70525900	1	2.5" DISCHARGE, LEFT - POSITION 2

Line	Item #	Qty	Item Description/Comments
289	61810150	1	DISCHARGE TERMINATION, 30 DEGREE ELBOW
290	71025908	1	3" DISCHARGE W/4" OUTLET, RIGHT - POSITION 3
291	61810160	1	DISCHARGE TERMINATION, STRAIGHT
292	61840270	1	ADAPTER, 4" NST FE X 5" STORZ W/CAP & CHAIN, TFT
293	71025900	1	2.5" DISCHARGE, RIGHT - POSITION 4
294	61810150	1	DISCHARGE TERMINATION, 30 DEGREE ELBOW
295	71890000	1	DISCHARGE 2.5" RIGHT REAR
296	61810150	1	DISCHARGE TERMINATION, 30 DEGREE ELBOW
297	72290000	1	1.5" FRONT BUMPER DISCHARGE, 2" PLUMBING
298		1	<i>Front Bumper Swivel Location/Side = Driver's side.</i>
299		1	<i>Front Discharge Swivel Location/Trough = Top of Bumper.</i>
300	72590002	1	DECK GUN DISCHARGE 3"
301	72570100	1	DECK GUN TERMINATION, THREADED
302	72554800	1	MONITOR, AKRON APOLLO 3423 W/QUAD STACKED TIPS & STREAM SHAPER
303			(1) Standard Apollo (1) 3488 Stream Shaper (1) 2499 Quad Stacked Tips (1) Direct Mount Flange (1) LDH Single 5" Storz Inlet Ground Base
304	72570200	1	EXTEND-A-GUN, TASK FORCE TIPS XG18, MANUAL
305	72890005	1	CROSSLAY, ONE 2.5" & SPEEDLAYS, TWO 2" W/SWIVELS & ALUMINUM LIFT-OUT TRAYS
306	72888888	1	SPECIAL ITEM, CHANGE OUT POLY TRAYS TO ALUMINUM TRAYS
307			<i>4 Total Alum Trays to be provided</i>
308		1	<i>Crosslay Hose Load Requirement = (2) 200' - 1 3/4" 200' - 2.5"</i>
309	72910805	1	COVERS, ALUM/VINYL FOR CROSSLAY/SPEEDLAY
310		1	<i>Crosslay/Speedlay Side Covers Color = Black.</i>
311	72932201	1	COVER FASTENERS, BUNGIE CORDS WITH RED TAB
312		1	<i>Specify details for side covers: Number of flaps, fasteners &amp; and how they terminate (manufacturer's discretion or customer specified?) = TBD @ Pre-Con.</i>



Line	Item #	Qty	Item Description/Comments
313	61742000	1	MASTER PUMP DRAIN, MULTIPOINT
314	61790510	10	DRAIN VALVES, HALE, LIFT-UP (10)
<b>FOAM SYSTEM</b>			
315		1	<i>Class of Foam = Class A Foam</i>
316	73590100	1	FOAM SYSTEM, HALE SMARTFOAM 2.1A (PRG)
317	73531425	1	FOAM TANK 30 GALLON BUILT INTO BOOSTER TANK
318	73576720	1	QUARTER TURN VALVE, MANUAL FOAM FLUSH
<b>PUMP PANEL</b>			
319	74914130	1	PRG SM3 - SIDE MOUNT PUMP PANEL (CROSSLAY/SPEEDLAYS)
320	74928100	1	PUMP MODULE LENGTH, 44"
321	74929130	1	HALE PUMP MODULE CONFIGURATION, SIDE MOUNT, CROSSLAY W/ SPEEDLAYS
322	74930710	1	PANEL FINISH, BRUSHED STS 14 GAUGE (PRG)
323		1	<i>Pump Panel Label Verbiage Standard = Yes.</i>
324	74931055	1	COLOR CODING (PRG)
325		1	<i>Color Coding Standard = Yes.</i>
326	74931290	1	PUMP MODULE FRAMEWORK, SWIRL FINISH
327	74931390	1	PUMP FINISH, PAINTED BY PUMP MFG
328	74931590	1	PLUMBING FINISH, NON-PAINTED
329	74931690	1	EXTERIOR DUNNAGE AREA PANEL, BRUSHED STS
330	75590010	1	PUMP OPERATOR LIGHTS, LED (PRG)
331	75590110	1	PUMP PANEL LIGHTS OFFICER'S SIDE, LED (PRG)
332	76090002	1	PUMP PANEL GAUGES & CONTROLS (PRG)
333	60090030	1	PUMP PRIMER, TRIDENT, AIR
334	60028320	1	(2) PRIMER BUTTONS - MAIN & FRONT SUCTION
335		1	<i>Auxiliary Pump Primer Switch Location = Mount suction auxiliary primer switch as close as possible to intake valve controller.</i>
336	76025110	1	COMPRESSION FITTINGS ON AIR SYSTEM (PRG PUMP MODULE)

Line	Item #	Qty	Item Description/Comments
337	76030900	1	HALE TRV-L THERMAL RELIEF VALVE WITH LIGHT AT PUMP PANEL
338	76031900	1	AIR HORN PUSH BUTTON SWITCH ON PUMP PANEL
339	77090000	1	GAUGE, DISCH, CLASS 1 2.5" (ALL)
340	76590000	1	GAUGES, MASTER, CLASS 1 4.5" (PRG)
341	77590000	1	GAUGE, WATER LEVEL, CLASS 1, INTELLI-TANK ITL-4
342	77532112	1	GAUGE, WATER LEVEL, WHELEN PSTANK2 LED (2)
343		1	<i>Whelen Gauge Locations = Driver's side of Cab, behind Crew Door, high.</i>
344		1	<i>Whelen Gauge Locations = Officer's side of Cab, behind Crew Door, high.</i>
345		1	<i>Add'l Whelen Water Level Gauge Color Multi Color.</i>
346	77590040	1	GAUGE, FOAM LEVEL, CLASS 1, INTELLI-TANK ITL-4
347		1	<i>Class of Foam for Foam Gauge = Class A.</i>
<b>WATER TANK</b>			
348	83525200	1	WATER TANK BRAND, UPF
349	83590005	1	WATER TANK, 1000 GAL, POLY
<b>BODY</b>			
350	80189590	1	BODY G9 - ALUM 40/51 LADDERS THRU TANK
351	80089500	1	BODY SUBFRAME, PROGRAM 1 PUMPER
352	80245012	1	UPPER HATCH COMPARTMENT, LEFT & RIGHT SIDES
<b>BODY COMPARTMENTS</b>			

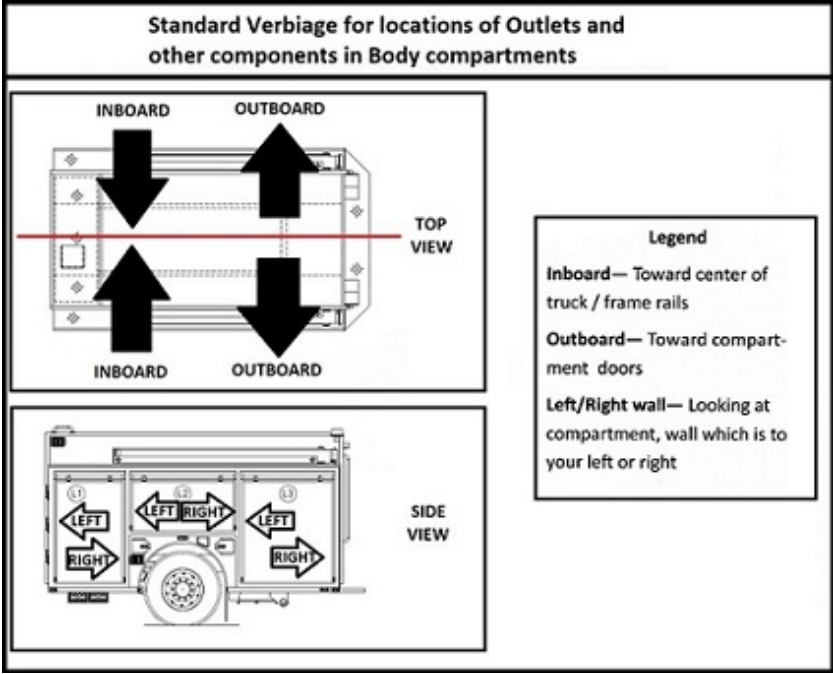
Line	Item #	Qty	Item Description/Comments
			<p style="text-align: center;"><b>Standard Verbiage for locations of Outlets and other components in Body compartments</b></p>  <p>The diagram includes a 'TOP VIEW' showing a rectangular compartment with a red horizontal line across the center. Arrows labeled 'INBOARD' point towards the center line, and arrows labeled 'OUTBOARD' point away from it. Below this is a 'SIDE VIEW' showing the compartment's profile with arrows labeled 'LEFT' and 'RIGHT' indicating the viewing direction. A legend box on the right defines: 'Inboard— Toward center of truck / frame rails', 'Outboard— Toward compartment doors', and 'Left/Right wall— Looking at compartment, wall which is to your left or right'.</p>
353	81165705	1	UNISTRUT TRACK IN COMPTS
354	80290016	1	COMPT DOORS, HINGED, ALUM, PAINTED
355	80225100	1	REAR COMPT DOOR (A1) AMDOR ROLL-UP, SATIN FINISH
356	80230300	1	COMPT INTERIOR FINISH, SMOOTH
357	80230400	1	HINGED COMPT DOORS INTERIOR FINISH, SMOOTH
358	84531220	1	COMPT LIGHTING, FEDERAL SIGNAL COMPLEX LED LIGHT STRIPS, 2 PER COMPT
359	80288888	1	SPECIAL ITEM, 12 VOLT OUTLETS IN SIX COMPARTMENTS
360		1	<i>All 12v outlets will be high on the rear wall frontward in each compartment except the A1</i>
<b>BODY EXTERIOR</b>			
361	81380000	1	HOSEBED W/REMOVABLE ALUMINUM FLOORING
362		1	<i>List the Hose Bed Hose Load Req. = 1000' - 5" 400' - 2.5" 150' - 1 3/4"</i>
363	81330100	1	STANDARD HOSEBED HEIGHT
364	81410200	1	COVER, ALUMINUM 2 PC, MAIN HOSE BED
365	81331155	1	ALUM HOSEBED COVER SUPPORT, REMOVABLE REAR
366	81431210	1	REAR HOSEBED COVER, WEBBING

Line	Item #	Qty	Item Description/Comments
367		1	<i>Hosebed Cover Color = Black.</i>
368	81440230	1	<b>COVER FASTENERS, METAL AIRPLANE LATCHES</b>
369		1	<i>Specify number of rear flaps, fasteners &amp; and how they terminate (manufacturer's discretion or customer specified?) = TBD @ Pre-Con.</i>
370	81330303	1	<b>HOSE BED DIVIDERS, ADJ (3)</b>
371	81332020	1	<b>HOSEBED LIGHTING, FRONT, FEDERAL SIGNAL COMPLEX LED LIGHT STRIP</b>
372	81332120	1	<b>HOSEBED LIGHTING, SIDES, FEDERAL SIGNAL COMPLEX LED LIGHT STRIPS</b>
373	81910100	1	<b>HANDRAILS, KNURLED STS</b>
374	82290010	1	<b>STEPS, FRONT BODY, IC FOLD DOWN W/LIGHT</b>
375		1	<i>Step Light Color = Blue.</i>
376	82390001	1	<b>STEPS, REAR BODY (14x11 &amp; 14x8)</b>
377	82510000	1	<b>RUB RAILS, ANODIZED ALUM</b>
378	83010050	1	<b>ALUMINUM TREADPLATE (ALUM PPR, PRG1, C-SER, TANKER)</b>
379	83030350	1	<b>REAR STEP/TAILOBOARD CORNERS, 45 DEGREE (PRG1)</b>
380	80290052	1	<b>10 SCBA CYLINDER COMPTS (3 TRIPLE-FMI, 1 SINGLE-SIG4)</b>
381		1	<i>A triple bottle compartment cannot be located on the driver's side behind rear axle.</i>
382	80290230	1	<b>DIVIDER FOR (3) TRIPLE SCBA COMPARTMENTS</b>
383		1	<i>Location of Dividers for Triple SCBA Compartments = Triple SCBA Compartment = Front of DS Wheel Well Single SCBA Compartment = Rear of DS Wheel Well Triple SCBA Compartment = Front of OS Wheel Well Triple SCBA Compartment = Rear of OS Wheel Well</i>
384	80290310	1	<b>DOOR FINISH, BRUSHED STAINLESS, SINGLE/DOUBLE SCBA COMPT (1)</b>
385	80290420	3	<b>DOOR FINISH, BRUSHED STAINLESS, TRIPLE SCBA COMPT (3)</b>
386	88520100	1	<b>SUCTION HOSE, (2) 10' SECT 6" KOCHER LIGHTWEIGHT</b>
387		1	<i>Suction Hose Location = SUCTION HOSE MOUNTED IN LADDER CHUTE</i>
388	88540350	1	<b>SUCTION HOSE MOUNTED IN LADDER CHUTE</b>
389	88550300	1	<b>STRAINER NOT PROVIDED</b>
390	83030705	1	<b>REAR FENDERS, ALUMINUM TREADPLATE</b>

Line	Item #	Qty	Item Description/Comments
391	89011500	1	ALCO-LITE PEL-24 24'2 SEC & PRL-14 14' ROOF & 10' FOLDING
392	89590007	1	LADDER CHUTE W/SUCTION HOSE STORAGE & PIKE POLE STORAGE
393	89088888	1	<b>SPECIAL ITEM, POLY LADDER CHUTE</b>
394	89520210	1	LADDER ENCLOSURE, DIAMONDPLATE DOOR
<b>ELECTRICAL</b>			
395	80232100	1	2" RECEIVER, SIDES
396	80232110	1	2" RECEIVER, REAR
397	80232175	3	WIRING FOR WINCH RECEIVER (3)
398		1	<i>Type of Plug for Body Winch Receiver = Grey Plug Receiver</i>
399	84550110	1	LICENSE PLATE BRACKET W/ LIGHT, LED
400	84511100	1	BODY ELECTRICAL DESCRIPTION
401	84520000	1	BACK UP ALARM, ECCO SA917
402	85010302	1	TAILLIGHTS, WHELEN 600 SERIES, LED STOP/TAIL/TURN/REVERSE, QUAD HOUSING (PAIR)
403		1	<i>Tail Light Housing Color = Chrome.</i>
404	85110100	1	ICC LIGHTS, LED
405	85510200	1	STEP LIGHTS, LED, REAR BODY & WHELEN 2G AT PUMP PANEL
406	85710010	1	UNDERCARRIAGE GROUND LIGHTS, TRUCK-LITE #44042C LED
407	86528999	1	DELETE REAR WORK LIGHTS
408	86600000	1	OPTICAL WARNING SYSTEM, UPPER (PUMPER)

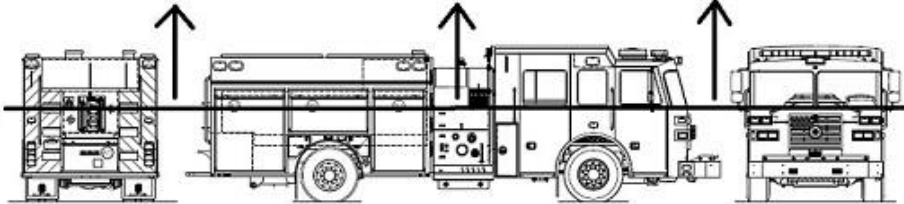
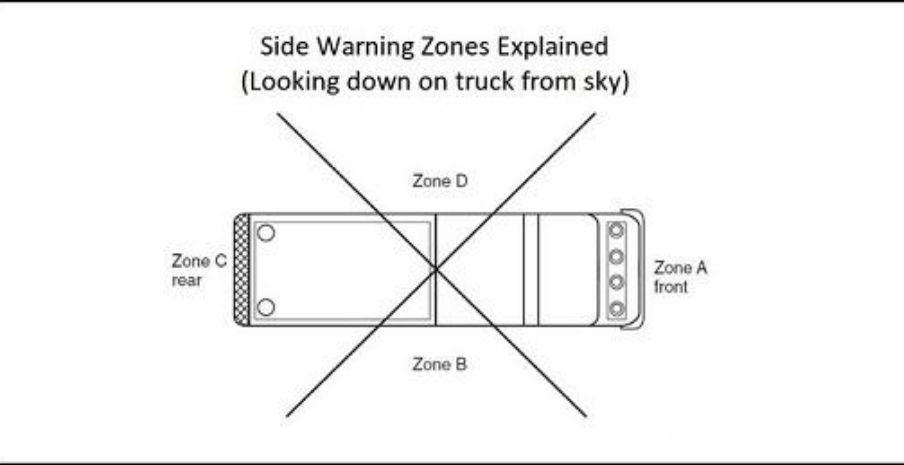
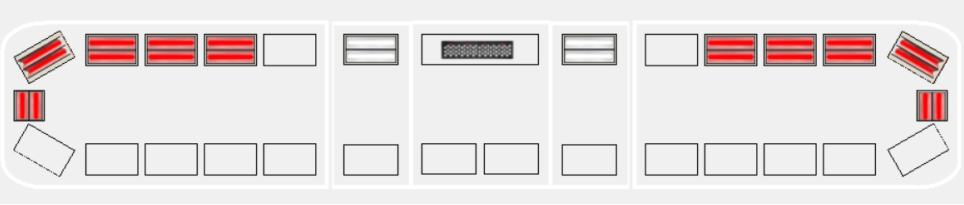
Line	Item #	Qty	Item Description/Comments
			<p style="text-align: center;">UPPER WARNING SYSTEM (FROM BOTTOM OF WINDSHIELD UP)</p>  <hr/> <p style="text-align: center;">Side Warning Zones Explained (Looking down on truck from sky)</p> 
409	86610120	1	UPPER WARNING LIGHTS, ZONE A (FRONT), WHELEN FREEDOM IV 72" LED LIGHT BAR, F4N7QLED, 12 MODULES
			
410	86920100	1	UPPER ZONE A LIGHTBAR, STANDARD CONFIGURATION
411		1	<i>Zone A, Upper Lightbar Standard Configuration =  Color = 10 Red / 2 Clear  Lens Color = Clear  Ambient light photo eye to be added to light bar function</i>
412	86910110	1	OPTICOM, INSTALLED IN LIGHT BAR, GTT 795H LED (FOR WHELEN LIGHTBAR)
413			<i>Ambient Light Sensor to be installed in the DS A-Pillar Reference HS-6820</i>
414	86988888	1	SPECIAL ITEM, OVERRIDE SWITCH FOR OPTICOM
415			SWITCH DETAIL = Location = UCC#1 Function will be a three-position rocker switch:

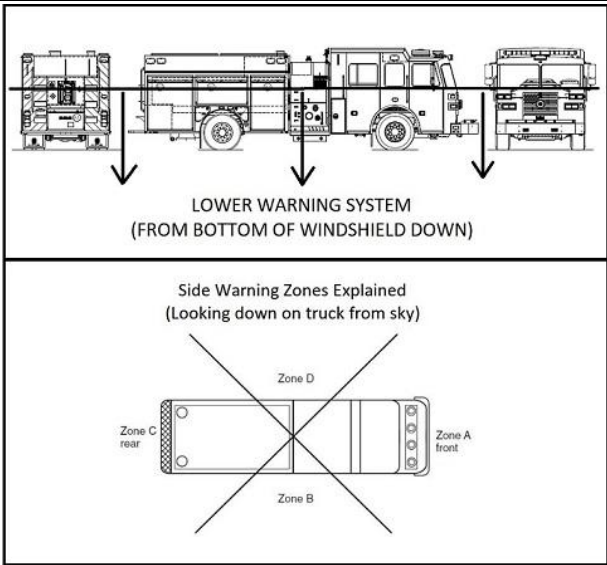
Line	Item #	Qty	Item Description/Comments
			<i>Top ON will turn on without Emergency Master (OFF with Park Brake)  Middle (Standard Function) ON with Emergency Master  Bottom OFF will Override all function to OFF</i>
416	86699999	1	<b>UPPER WARNING LIGHTS, ZONE B (OFFICER'S SIDE), COVERED BY ZONES A &amp; C</b>
417	86728888	1	<b>SPECIAL WLUpperC DELETE BEACONS, 900 SERIES IN PLACE OF BEACONS</b>
418		1	<b>NO BEACONS, 900 SERIES FLASHING LIGHTS ON REAR OF BODY HIGH ON BACK OF BODY AND SIDE OF UPPER BODY, MATCH MADISON HGTS LIGHTING ON BODY INCLUDING SCENE LIGHTING</b>
419		1	<i>Zone C, Upper Rear Beacon Color/Details =  (1) Pair Mounted Rear of the Body  DS =  Color = Green  Lens Color = Clear  OS =  Color = Red  Lens Color = Clear  (1) Pair Mounted to Rearward Side of Body  Color = Red  Lens Color = Clear  (1) Pair Mounted Forward Side of Body  Color = Red  Lens Color = Clear</i>
420	86899999	1	<b>UPPER WARNING LIGHTS, ZONE D (DRIVER'S SIDE), COVERED BY ZONES A &amp; C</b>
421	87100000	1	<b>OPTICAL WARNING SYSTEM, LOWER (PUMPER)</b>
			 <p style="text-align: center;">LOWER WARNING SYSTEM (FROM BOTTOM OF WINDSHIELD DOWN)</p> <p style="text-align: center;">Side Warning Zones Explained (Looking down on truck from sky)</p> <p style="text-align: center;">Zone D Zone C rear Zone A front Zone B</p>
422	87110110	1	<b>LOWER WARNING LIGHTS, ZONE A (FRONT), WHELEN 600 SUPER LED, 60*02F*R (QTY 4)</b>
423		1	<i>Zone A, Lower Warning Light Color, Lens Color, Details =  DS Outboard –  Color = Green  Lens Color = Clear  OS and DS Inboard –</i>

Line	Item #	Qty	Item Description/Comments
			Color = Red Lens Color = Clear
424	87811130	1	<b>LOWER, ZONE A - MOUNTING LOCATION (DUAL HOUSINGS)</b>
425		1	Zone A, Lower - Front, Mounting Location = (2) Warnings in top headlight housing, each side.
426	87210100	1	<b>SPECIAL, LOWER WARNING LIGHTS, ZONE B (OFFICER'S SIDE), WHELEN 600 SUPER LED, 60*02F*R (QTY 1), WHELEN 700 LED (QTY 1), ION T-SERIES LED, TLI* (QTY 1)</b>
427		1	Zone B, Lower Officer's Side Warning Light Color, Lens Color, Details = Color = Red Lens Color = Clear TLIR Color = Red Lens Color = Clear
428	87812110	1	<b>LOWER, ZONE B - MOUNTING LOCATION (PUMPERS, TANKERS, RESCUES)</b>
429		1	Zone B, Lower - Officer's Side, Mounting Location = (1) Warning Light near the front corner of the Apparatus. (600) (1) Warning Light near the rear Axle. (700) (1) Warning Light near the rear corner of the Apparatus. Reference Shop Order Drawing for lights and placement.
430	87310100	1	<b>LOWER WARNING LIGHTS, ZONE C (REAR), WHELEN 600 SUPER LED, 60*02F*R (QTY 2)</b>
431		1	Zone C, Lower Rear Warning Light Color, Lens Color, Details =
432	87410100	1	<b>SPECIAL, LOWER WARNING LIGHTS, ZONE D (DRIVER'S SIDE), WHELEN 600 SUPER LED, 60*02F*R (QTY 1), WHELEN 700 LED (QTY 1), ION T-SERIES TLI* (QTY 1)</b>
433		1	Zone D, Lower Driver's Side Warning Light Color, Lens Color, Details = (600) Color = Green Lens Color = Clear (700) Color = Red Lens Color = Clear TLIR Color = Red Lens Color = Clear
434	87814110	1	<b>LOWER, ZONE D - MOUNTING LOCATION (PUMPERS, TANKERS, RESCUES)</b>
435		1	Zone D, Lower - Driver's Side, Mounting Location = (1) Warning Light near the front corner of the Apparatus. (600) (1) Warning Light near the rear Axle. (700) (1) Warning Light near the rear corner of the Apparatus. Reference Shop Order Drawing for lights and placement.
436	87537732	1	<b>ADDITIONAL WARNING LIGHTS, WHELEN 700 SUPER LED, (PAIR) (1)</b>
437		1	Whelen 700 LED Warning Light Color = Color = Red Lens Color = Clear Mounting Location = Over Front Wheel Well



Line	Item #	Qty	Item Description/Comments
438	87537738	8	<b>ADDITIONAL WARNING LIGHTS, WHELEN ION T-SERIES LED, TLI*(PAIR) (8)</b>
439		1	<p><i>Whelen ION-T Warning Light Details</i>  <i>(4 Pair) Location = Interior L1/R1/L3/R3 Doors outer door when open</i>  <i>Color = Green</i>  <i>Lens Color = Clear</i></p> <p><i>(4 Pair) Location = Exterior L1/R1/L3/R3 Doors outer door when open</i>  <i>Color = Red</i>  <i>Lens Color = Clear</i></p> <p><i>THE ION-T GREEN LIGHTS (TWO PAIR) ARE TO BE MOUNTED ON THE INSIDE OF THE LEFT SIDE HINGED DOORS. THE LIGHTS WOULD BE FACING TO THE BACK OF THE TRUCK AND TO BE ACTIVATED WHEN THE DOORS ARE OPEN, THE SECOND PAIR SHALL BE RED IN COLOR AND MOUNTED ON THE OUTSIDE OF THE RIGHT DOORS, SO WHEN OPENED THEY WOULD BE VISIBLE FORWARD AND TO THE SIDE WHEN CLOSED</i></p>
440	87537742	3	<b>ADDITIONAL WARNING LIGHTS, WHELEN 900 SERIES LED, 90**5F*R (PAIR) (3)</b>
441		1	<b>Light Detail Provided Above in Upper Zone C</b>
442	87537750	1	<b>ADDITIONAL WARNING LIGHTS, WHELEN M6V2* LED (PAIR) (1)</b>
443		1	<p><i>Whelen M6V2LED Warning Light Detail =</i>  <i>Location = Front Bumper 45 Degree Pocket Either Side</i>  <i>Scene Light Activated with Ground Lights.</i></p>
444	87040000	1	<b>TRAFFIC ADVISOR, WHELEN LED, TAL65 36"</b>
445	88391200	2	<b>SCENE LIGHT, WHELEN PIONEER PFH2, 12V LED, BROW (2)</b>
446		1	<p><i>Scene Light Details =</i>  <i>MOUNTED ON CAB FACE SPACED APART</i>  <i>Switching = Brow / Upper Position 1, Upper Console Position #7</i>  <i>Housing Color = Black</i></p>
447	88391210	4	<b>SCENE LIGHT, WHELEN PIONEER PFH2, 12V LED, RECESSED (4)</b>
448		1	<p><i>Scene Light Details =</i>  <i>(1) Pair Either Side Middle of the Body</i>  <i>(1) Pair Either Side Above Fixed Window Location</i>  <i>Switching = Left Scene, Right Scene / Upper Position 1, Upper Console Position #7</i>  <i>Light Housings Color= Black</i></p>
449	86537811	1	<b>SCENE LIGHTS, WHELEN 900 LED, SURFACE MOUNT (PAIR) (1)</b>
450		1	<p><i>Light Mounting Location &amp; Switching =</i>  <i>(1) Pair Rear of the Body</i>  <i>Switching = Rear Scene / Upper Position 1, Upper Console Position #7</i>  <i>Reverse Activated</i></p>
451	88399940	4	<b>ADDITIONAL SWITCH, 3-WAY FOR 12V LIGHTS (EA) (4)</b>
452		1	<i>Location &amp; Function for Additional 3-Way Switches 12V =</i> <i>Officer's Side: Brow, Left Scene, Right Scene, Rear Scene</i>
<b>PAINT &amp; FINISH</b>			

Line	Item #	Qty	Item Description/Comments
453	89910000	1	CORROSION REDUCTION PROGRAM (SPECS)
454	90010020	1	PAINT SCHEME
455	90030010	1	TWO TONE CAB & BODY
456	90029910	1	PAINT BREAK #1 - BOTTOM OF WINDSHIELD
			
457		1	<i>Upper Color for Two Tone Paint = BLACK.</i>
458		1	<i>Lower Color for Two Tone Paint = RED.</i>
459	90030154	1	PAINT FRAME RAILS & BODY REAR DROP - BLACK
460	90030190	1	TEXTURED FRAME RAIL COATING
461	90030015	1	A/C CONDENSER PAINTED ROOF COLOR
462		1	<i>Note Paint AC Condenser Color = MATCH ROOF COLOR</i>
463	90510000	1	3" LETTERING, 22K UP TO 40
464	90530030	26	ADDITIONAL 8" 22KT LETTERS (EACH) (26)
465	90530305	1	BASIC 22KT GOLD FIRE DEPT EMBLEMS (Pair)
466	90610200	1	6" SCOTCHLITE STRIPE AROUND TRUCK
467	90630405	1	MITER EDGED "Z" STRIPE
468	90630100	2	1" SCOTCHLITE STRIPE ABOVE OR BELOW - EACH (2)
469	90680120	1	CHEVRON STRIPING, REAR BODY OUTBOARD, REFLEXITE
470		1	<i>Chevron Striping, Rear Body Color = #030 Red Transparent &amp; #L2 Fluorescent Lime.</i>
471	90670020	1	CHEVRON STRIPING, FRONT BUMPER, REFLEXITE

Line	Item #	Qty	Item Description/Comments
472		1	<i>Chevron Striping, Front Bumper Color = #030 Red Transparent &amp; #L2 Fluorescent Lime.</i>
473		1	<i>List Special Lettering/Striping Details = Reference HS-6820</i>
<b>EQUIPMENT</b>			
474	91010000	1	<b>MISC EQUIP - (1) PINT TOUCH-UP PAINT, STAINLESS STEEL NUTS &amp; BOLTS</b>
475			<i>Ship Loose Items: Pint touch-up paint, 1 per color Stainless steel nuts and bolts Fire extinguisher Warning triangles First Aid kit Auto Eject Plugin adapter Air Eject Female</i>
476	91030700	1	<b>ZIAMATIC SAC-44 FOLDING WHEEL CHOCKS (PAIR) MTD W/ SQCH-44H HOLDERS</b>
477		1	<i>Wheel Chock Mounting Locations = Under L1 Compartment</i>
478	89050700	1	<b>BACKBOARD STORAGE COMPARTMENT, HOSE BED</b>
479		1	<i>Size,Location = storage for 1 Backboard on the right side of the hosebed with a hinged door.</i>
<b>COMPLETION &amp; WARRANTY</b>			
480	99010000	1	<b>MANUALS (1-PRINTED &amp; 1-USB) WITH DVD</b>
481	10000215	1	<b>STD WIRING SCHEMATIC</b>
482	99031195	1	<b>DEALER DELIVERY</b>
483	99520110	1	<b>WARRANTY, ONE YEAR</b>
484	99521100	1	<b>WARRANTY, FRAME, LIFETIME</b>
485	99521200	1	<b>WARRANTY, CAB STRUCTURAL, 10 YR.</b>
486	99521300	1	<b>WARRANTY, BODY STRUCTURAL, 10 YR.</b>
487	99521400	1	<b>WARRANTY, PAINT, 10 YR.</b>
488	99521900	1	<b>WARRANTIES, MAJOR VENDOR COMPONENTS</b>
<b>DEALER SUPPLIED</b>			
489	PDB000219	1	<b>DEALER SUPPLIED - OTHER - FMI MOUNTING</b>
490	PDB000219	1	<b>DEALER SUPPLIED - OTHER - WHELEN CORE CONTROLLER, PREP FOR UPD, APOLLO TO MOUNT.</b>